

P/N

SR-RM 0803

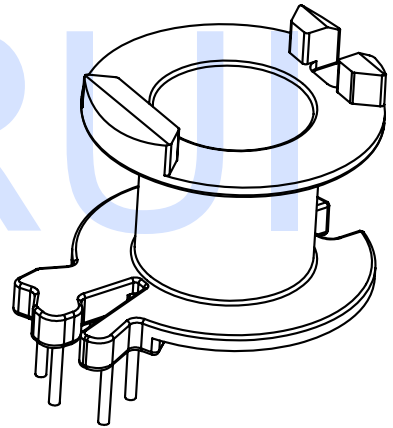
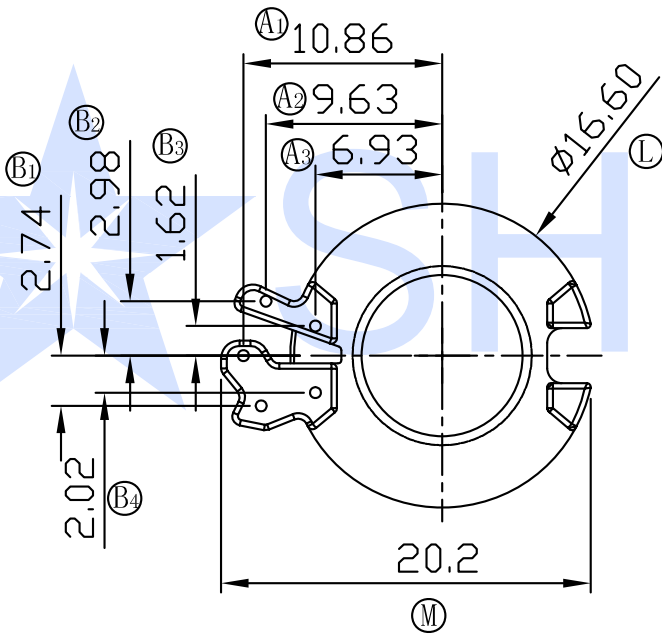
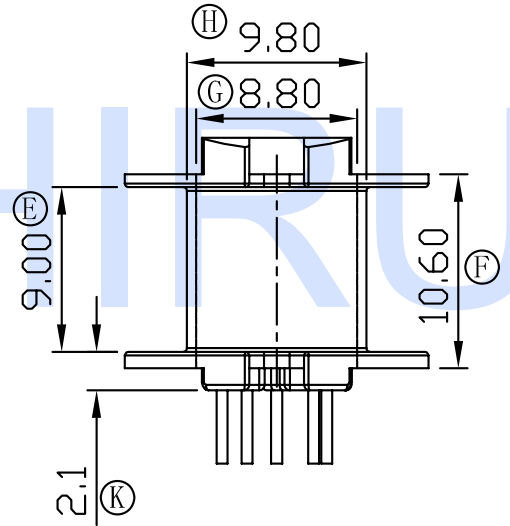
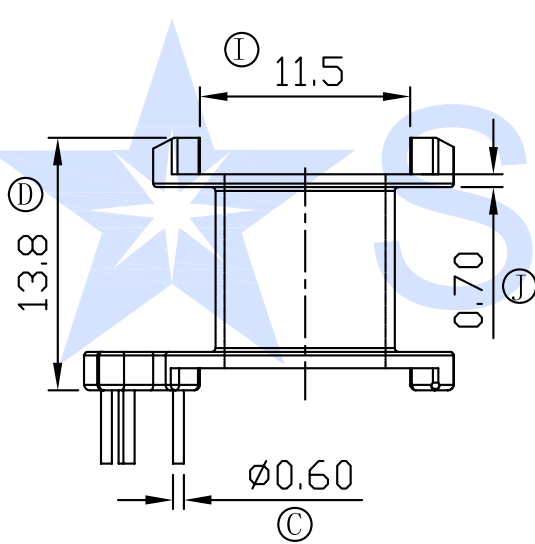

Hefei Shirui Electronic Technology Co.,Ltd

TEL:(0086) 55165232650

sales@shiruitech.com

www.shiruitech.com

SR NO. SR-RM 0803	MATERIAL: PHENOLIC	UNIT: mm	TOLERANCE	DRN.	WILL H
MODEL NAME! RM8-5P-1S V	UL REC: UL 94V-0		0 L 4 ±0.10	CHD.	IRINA LEE
	ANGLE: ±°		4 L 16 ±0.20	ISSD.	JAMES HU
	SCALE 1:1		16 L 64 ±0.30		
			PIN PITCH ±0.05		